

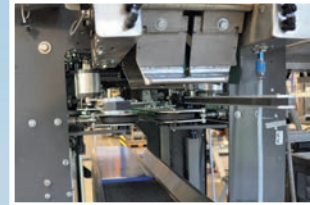

Manter[®]

weighing and packaging equipment

SAB 2

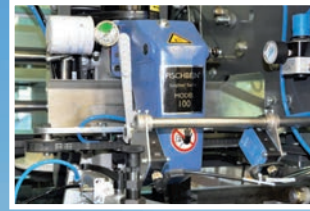

 - Half-automatische verpakker voor enkele net-, jute- en papieren zakken.

- Handmatig aanhangen van de enkele zakken, automatisch gesloten middels een industriële naaimachine.

- Verschillende extra sluitopties mogelijk Hamer of Kwiklok.

- Te combineren met alle weegmachines.

- Bediening door middel van gebruiksvriendelijke touchscreen.

 - Halb-Automatisch verpacken im einzelne Netz-, Jute- und Papier Säcke.

- Säcke werden handmässig unter die Füllöffnung gehängt, automatisch geschlossen mit einer Industrielle Nämaschine.

- Verschiedene schliessmöglichkeiten wie Hamer oder Kwiklok.

- Zu kombinieren mit allen Arten Wiegenmaschinen

- Zu bedienen mit Touchscreen.

 - Semi-automatic bagger for single net-, hessian and paper bags.

- Bags are hung manually under the filling hole, closed automatically with an industrial stitching-machine.

- Different closing options possible like hamer or kwiklok.

- To combine with all kinds of weighing systems.

- User friendly touchscreen.



All in weighing and packaging solutions

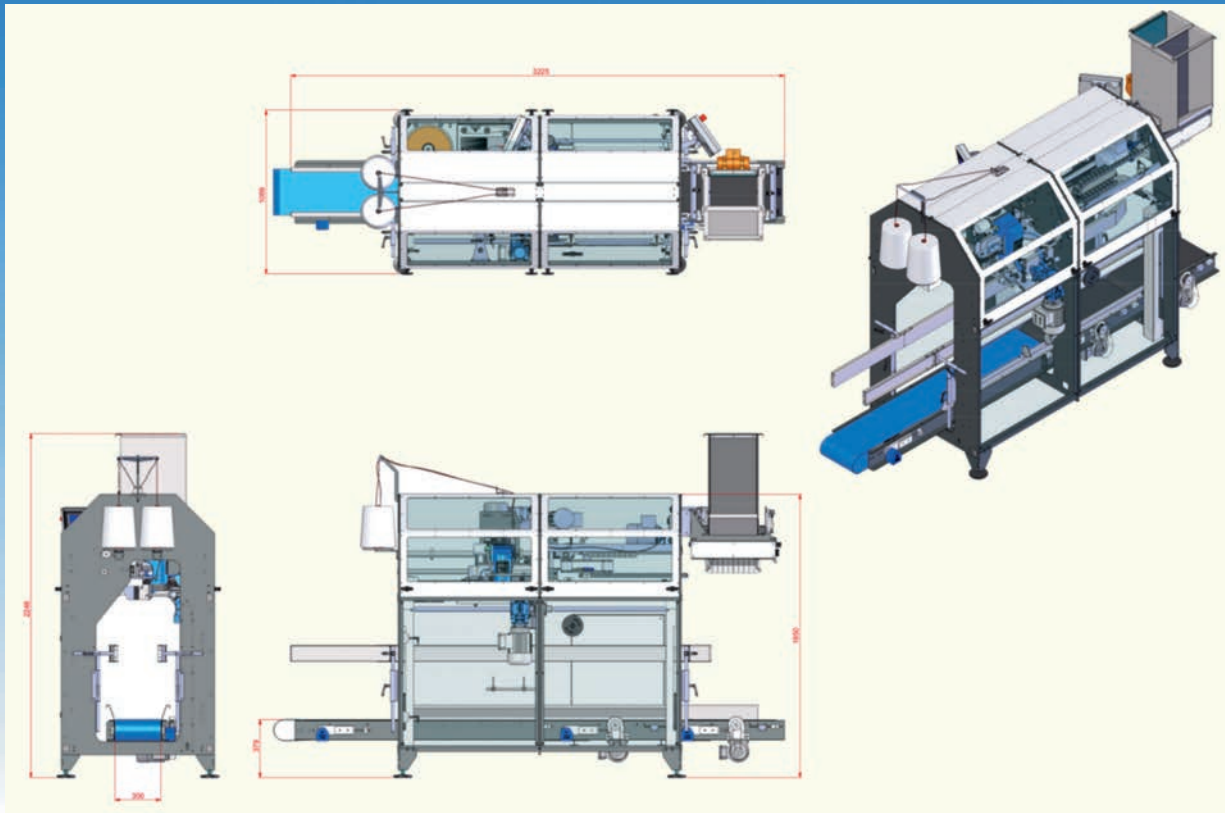

 Specificaties:

Verpakkingsbereik:
Capaciteit tot:
Lucht druk:
Lucht consumptie (gecondi-
tioneerde droge lucht):
Voedingsspanning:
Stroomverbruik:
Gewicht van de machine:

 Spezifikationen:

Verpackung Bereich
Leistung bis zu:
Luftdruck:
Luft Verbrauch (Kondi-
tionierte trockene Luft):
Spannungdaten:
Anschlusswert:
Gewicht der Maschine:

 Specifications:

Packing range:
Capacity up to:
Air pressure:
Air consumption
(conditioned dry air):
Supply Voltage:
Power consumption:
Weight of the machine:

10 - 25kg
16 pcs/min (25kg)¹
6 Bar

50L/min
3 x 400V/50Hz+N+GND
5,5 kW
650kg

¹ - Afhankelijk van product en afvoersysteem. - Abhängig von Product und Abtransportsystem. -
- Depending on product and discharge system. -



Manter International bv
Phileas Foggstraat 66
7825 AL Emmen - Holland
tel: +31 591 626300
e-mail: sales@manter.com

www.manter.com

- Manter behoudt zich het recht om apparatuur te wijzigen. -
- Änderungen an die Maschinen behält Manter sich vor. - Manter reserves the right to change the equipment. -